

PRIKLJUČCI SA STANDARDNIM NOGICAMA "MANULI" ZA V.T. GUMENE, TERMOPLASTIČNE I PTFE OPLETENE CIJEVI

TIP | OZNAKA / PRIMJENA | STANDARD / NAPOMENA

A M	DKM	DIN 20078 / 3863
A M10x1 - NP 3		
A M10x1 - NP 5		
A M12x1,5 - NP 5		
A M12x1,5 - NP 6		
A M14x1,5 - NP 6		
A M16x1,5 - NP 8		
A M18x1,5 - NP 10		
A M22x1,5 - NP 13		
A M26x1,5 - NP 16		
A M30x1,5 - NP 19		
A M38x1,5 - NP 25		
A M45x1,5 - NP 32		

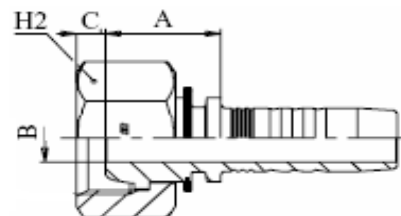

A M L45	DKM - 45	DIN 20078 / 3863
A M10x1 L45 NP 5		
A M12x1,5 L45 NP 6		
A M14x1,5 L45 NP 6		
A M16x1,5 L45 NP 8		
A M18x1,5 L45 NP 10		
A M22x1,5 L45 NP 13		
A M26x1,5 L45 NP 16		

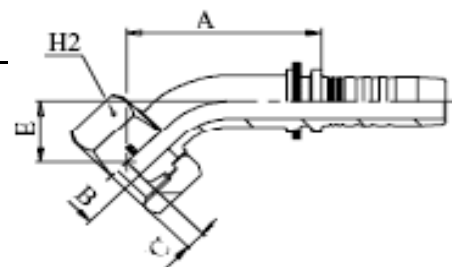

A M L90	DKM - 90	DIN 20078 / 3863
A M10x1 L90 NP 3		
A M10x1 L90 NP 5		
A M12x1,5 L90 NP 6		
A M14x1,5 L90 NP 6		
A M16x1,5 L90 NP 8		
A M18x1,5 L90 NP 10		
A M22x1,5 L90 NP 13		
A M26x1,5 L90 NP 16		
A M30x1,5 L90 NP 19		
A M38x1,5 L90 NP 25		

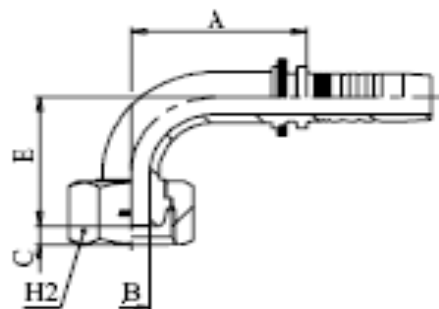

A R	DKR / DKOR	-
A R 1/8" - NP 3		
A R 1/8" - NP 5		
A R 1/8" - NP 6		
A R 1/4" - NP 6		
A R 1/4" - NP 8		
A R 3/8" - NP 6		
A R 3/8" - NP 8		
A R 3/8" - NP 10		
A R 1/2" - NP 8		
A R 1/2" - NP 10		
A R 1/2" - NP 13		
A R 5/8" - NP 13		
A R 5/8" - NP 16		
A R 3/4" - NP 13		
A R 3/4" - NP 16		
A R 3/4" - NP 19		
A R1" - NP 19		
A R1" - NP 25		

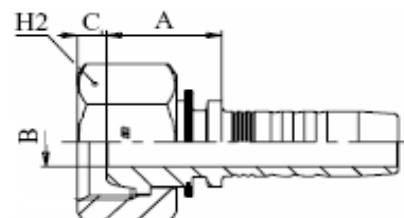

A R1.1/4" - NP 25
 A R1.1/4" - NP 32
 A R1.1/2" - NP 32
 A R1.1/2" - NP 38
 A R2" - NP 50

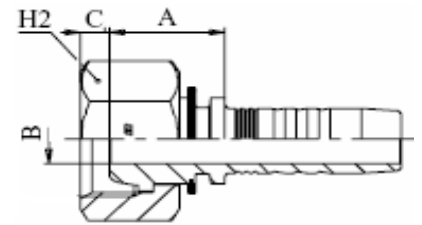

A R L45	DKR / DKOR - 45	-
A R 1/4" L45 NP 6		
A R 3/8" L45 NP 8		
A R 3/8" L45 NP 10		
A R 1/2" L45 NP 10		
A R 1/2" L45 NP 13		
A R 5/8" L45 NP 13		
A R 5/8" L45 NP 16		
A R 3/4" L45 NP 16		
A R 3/4" L45 NP 19		
A R1" L45 NP 19		
A R1" L45 NP 25		
A R1.1/4" L45 NP 32		
A R1.1/2" L45 NP 38		
A R2" L45 NP 50		

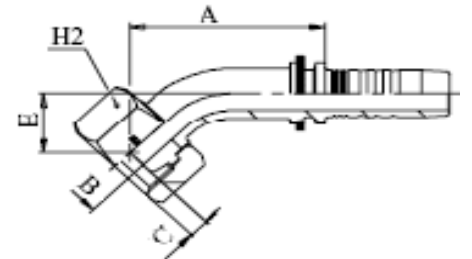

A R L90	DKR / DKOR - 90	-
A R 1/8" L90 NP 3		
A R 1/8" L90 NP 5		
A R 1/8" L90 NP 6		
A R 1/4" L90 NP 6		
A R 1/4" L90 NP 8		
A R 3/8" L90 NP 6		
A R 3/8" L90 NP 8		
A R 3/8" L90 NP 10		
A R 1/2" L90 NP 10		
A R 1/2" L90 NP 13		
A R 5/8" L90 NP 13		
A R 5/8" L90 NP 16		
A R 3/4" L90 NP 13		
A R 3/4" L90 NP 16		
A R 3/4" L90 NP 19		
A R1" L90 NP 19		
A R1" L90 NP 25		
A R1.1/4" L90 NP 25		
A R1.1/4" L90 NP 32		
A R1.1/2" L90 NP 32		
A R1.1/2" L90 NP 38		
A R2" L90 NP 50		

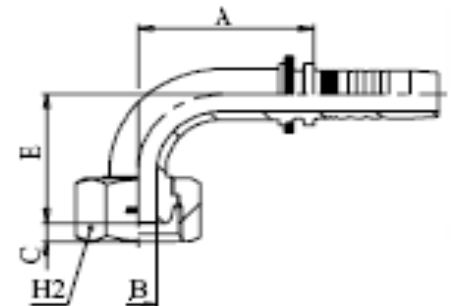

A R L90K	DKOR - 90 - K	-
A R 1/8" L90K NP 5		
A R 1/4" L90K NP 6		
A R 3/8" L90K NP 8		
A R 3/8" L90K NP 10		
A R 1/2" L90K NP 13		
A R 5/8" L90K NP 16		
A R 3/4" L90K NP 19		
A R1" L90K NP 25		

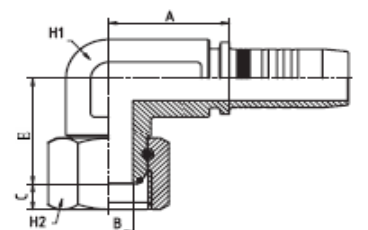

A R okr ***	DKOR rotofit	okretni priključak s ugrađenim ležajem
A R 3/8" okr - NP 10		
A R 1/2" okr - NP 13		
A R 5/8" okr - NP 16		
A R 3/4" okr - NP 19		
A R1" okr - NP 25		

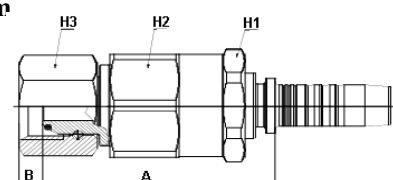

B (M)	RNM	DIN 7642
B 10 - NP 3		
B 10 - NP 5		
B 10 - NP 6		
B 12 - NP 6		
B 14 - NP 6		
B 14 - NP 8		
B 14 - NP 10		
B 16 - NP 8		
B 16 - NP 10		
B 16 - NP 13		
B 18 - NP 10		
B 18 - NP 13		
B 22 - NP 13		
B 22 - NP 16		
B 26 - NP 19		

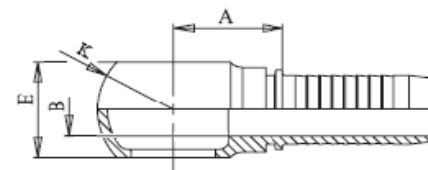

Šuplji vijci M	BFM	DIN 7643
Šuplji vijak M10x1		
Šuplji vijak M12x1,5		
Šuplji vijak M14x1,5		
Šuplji vijak M16x1,5		
Šuplji vijak M18x1,5		
Šuplji vijak M22x1,5		
Šuplji vijak M26x1,5		

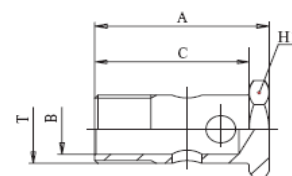

B (R)	RNR	-
B 1/8" - NP 3		
B 1/8" - NP 5		
B 1/4" - NP 6		
B 3/8" - NP 8		
B 3/8" - NP 10		
B 1/2" - NP 10		
B 1/2" - NP 13		
B 5/8" - NP 16		
B 3/4" - NP 19		
B 1" - NP 25		

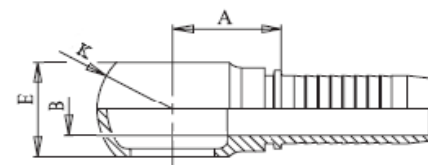

Šuplji vijci R	BFG	-
Šuplji vijak R1/8"		
Šuplji vijak R1/4"		
Šuplji vijak R3/8"		
Šuplji vijak R1/2"		
Šuplji vijak R 5/8"		
Šuplji vijak R 3/4"		
Šuplji vijak R1"		

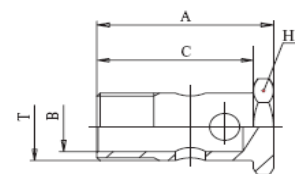

C R	DKR - F	-
C R 1/4" - NP 6		
C R 3/8" - NP 10		
C R 1/2" - NP 13		
C R 3/4" - NP 13		
C R 3/4" - NP 19		
C R1" - NP 25		

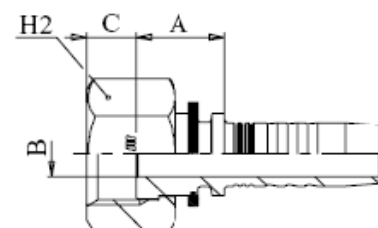

C R p	HIAB	produžena matica
C R 1/2" p - NP 8		
C R 1/2" p - NP 10		
C R 3/4" p - NP 13		
C R 3/4" p - NP 16		

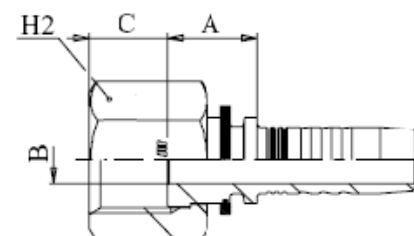

C R p L90	HIAB	produžena matica
C R 3/4" p L90 NP 13		
C R 3/4" p L90 NP 16		

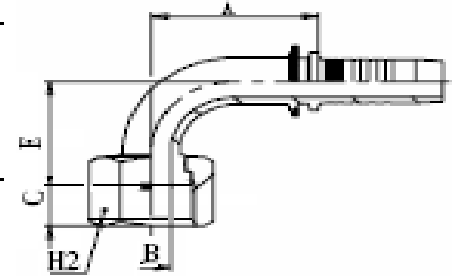

C UN/UNF/UNS	DK-ORFS	SAE J1453
C UNF 9/16" - NP 6		
C UN 11/16" - NP 6		
C UN 11/16" - NP 8		
C UN 11/16" - NP 10		
C UN 13/16" - NP 10		
C UN 13/16" - NP 13		
C UNS1" - NP 13		
C UNS1" - NP 16		
C UNS1" - NP 19		
C UN 1. 3/16" - NP 13		
C UN 1. 3/16" - NP 16		
C UN 1. 3/16" - NP 19		
C UN 1. 7/16" - NP 19		
C UN 1. 7/16" - NP 25		
C UN 1.11/16" - NP 32		
C UN 2" - NP 38		

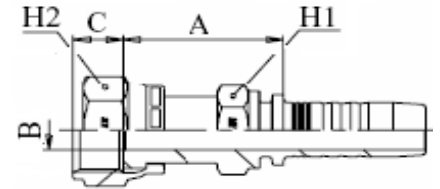

C UN/UNF/UNS L45	DK-ORFS - 45	SAE J1453
C UNF 9/16" L45 NP 6		
C UN 11/16" L45 NP 6		
C UN 11/16" L45 NP 8		
C UN 11/16" L45 NP 10		
C UN 13/16" L45 NP 10		
C UN 13/16" L45 NP 13		
C UNS1" L45 NP 16		
C UN 1. 3/16" L45 NP 16		
C UN 1. 3/16" L45 NP 19		
C UN 1. 7/16" L45 NP 19		
C UN 1. 7/16" L45 NP 25		
C UN 1.11/16" L45 NP 32		
C UN 2" L45 NP 38		

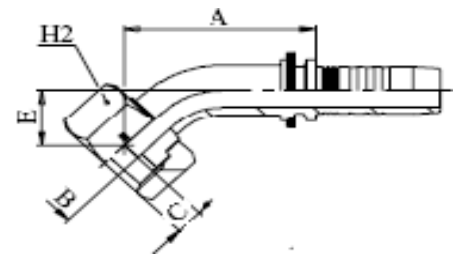

C UN/UNF/UNS L90	DK-ORFS - 90	SAE J1453
C UNF 9/16" L90 NP 6		
C UN 11/16" L90 NP 6		
C UN 11/16" L90 NP 8		
C UN 11/16" L90 NP 10		
C UN 13/16" L90 NP 10		
C UN 13/16" L90 NP 13		
C UNS1" L90 NP 13		
C UNS1" L90 NP 16		
C UN 1. 3/16" L90 NP 16		
C UN 1. 3/16" L90 NP 19		
C UN 1. 7/16" L90 NP 19		
C UN 1. 7/16" L90 NP 25		
C UN 1.11/16" L90 NP 32		
C UN 2" L90 NP 38		

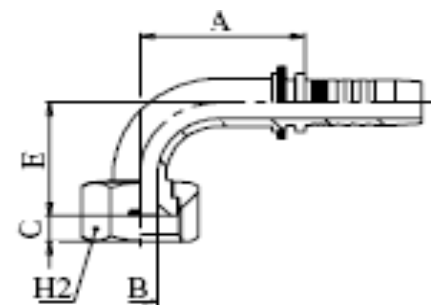

C UN/UNF L90P	DK-ORFS - 90 - P	SAE J1453
C UNF 9/16" L90P NP 6		
C UN 11/16" L90P NP 10		
C UN 13/16" L90P NP 10		
C UN 13/16" L90P NP 13		
C UN 1. 3/16" L90P NP 16		
C UN 1. 3/16" L90P NP 19		
C UN 1. 7/16" L90P NP 25		

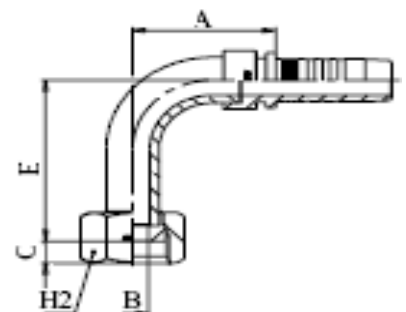

C UN/UNS okr ***	DK-ORS rotofit	okretni priključak s ugrađenim ležajem
------------------	----------------	--

C UN 11/16" okr - NP 10
 C UN 13/16" okr - NP 13
 C UNS1" okr - NP 16
 C UN 1.3/16" okr - NP 19
 C UN 1.7/16" okr - NP 25

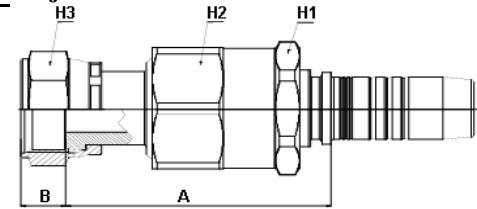

D M	-	-
-----	---	---

D M14x1,5 - NP 6
 D M16x1,5 - NP 8
 D M18x1,5 - NP 10
 D M22x1,5 - NP 13
 D M27x2 - NP 16
 D M33x2 - NP 19
 D M39x2 - NP 25

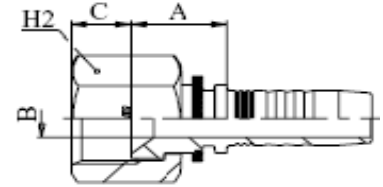

D M L90	-	-
---------	---	---

D M14x1,5 L90 NP 6
 D M16x1,5 L90 NP 8
 D M18x1,5 L90 NP 10
 D M22x1,5 L90 NP 13
 D M27x2 L90 NP 16
 D M33x2 L90 NP 19
 D M39x2 L90 NP 25

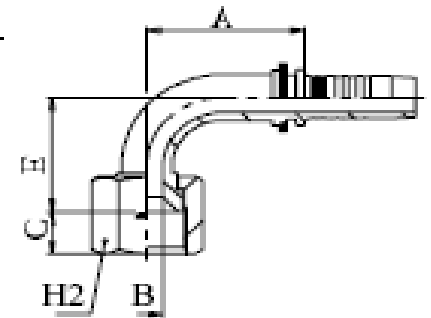

D UN/UNF	DKJ (JIC)	SAE J514
----------	-----------	----------

D UNF 7/16" - NP 3
 D UNF 7/16" - NP 5
 D UNF 7/16" - NP 6
 D UNF 1/ 2" - NP 6
 D UNF 1/ 2" - NP 8
 D UNF 9/16" - NP 6
 D UNF 9/16" - NP 8
 D UNF 9/16" - NP 10
 D UNF 5/ 8" - NP 10
 D UNF 3/ 4" - NP 10
 D UNF 3/ 4" - NP 13
 D UNF 7/ 8" - NP 10
 D UNF 7/ 8" - NP 13
 D UNF 7/ 8" - NP 16
 D UNF 7/ 8" - NP 19
 D UN1.1/16" - NP 13
 D UN1.1/16" - NP 16
 D UN1.1/16" - NP 19
 D UN1.1/16" - NP 25
 D UN1.3/16" - NP 19
 D UN1.5/16" - NP 19
 D UN1.5/16" - NP 25
 D UN1.5/ 8" - NP 25
 D UN1.5/ 8" - NP 32
 D UN1.7/ 8" - NP 38

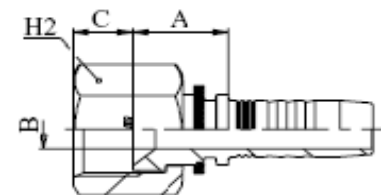

D UN/UNF L45	DKJ - 45 (JIC)	SAE J514
--------------	----------------	----------

D UNF 7/16" L45 NP 6
 D UNF 1/ 2" L45 NP 6
 D UNF 9/16" L45 NP 6
 D UNF 9/16" L45 NP 8
 D UNF 9/16" L45 NP 10
 D UNF 3/ 4" L45 NP 10
 D UNF 3/ 4" L45 NP 13
 D UNF 7/ 8" L45 NP 13
 D UNF 7/ 8" L45 NP 16

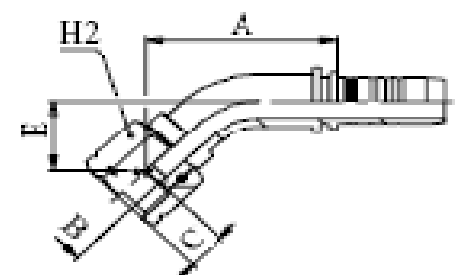

D UN1.1/16" L45 NP 13
 D UN1.1/16" L45 NP 16
 D UN1.1/16" L45 NP 19
 D UN1.3/16" L45 NP 19
 D UN1.5/16" L45 NP 19
 D UN1.5/16" L45 NP 25
 D UN1.5/ 8" L45 NP 32

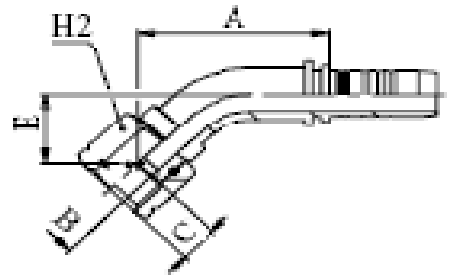

D UN/UNF L90	DKJ - 90 (JIC)	SAE J514
D UNF 7/16" L90 NP 5		
D UNF 7/16" L90 NP 6		
D UNF 1/ 2" L90 NP 6		
D UNF 1/ 2" L90 NP 8		
D UNF 9/16" L90 NP 6		
D UNF 9/16" L90 NP 8		
D UNF 9/16" L90 NP 10		
D UNF 5/ 8" L90 NP 10		
D UNF 3/ 4" L90 NP 10		
D UNF 3/ 4" L90 NP 13		
D UNF 7/ 8" L90 NP 10		
D UNF 7/ 8" L90 NP 13		
D UNF 7/ 8" L90 NP 16		
D UN1.1/16" L90 NP 13		
D UN1.1/16" L90 NP 16		
D UN1.1/16" L90 NP 19		
D UN1.3/16" L90 NP 19		
D UN1.5/16" L90 NP 19		
D UN1.5/16" L90 NP 25		
D UN1.5/ 8" L90 NP 32		
D UN1.7/ 8" L90 NP 38		

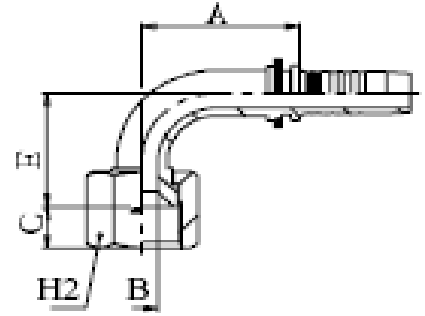

D UN/UNF L90K	DKJ - 90 - K (JIC)	SAE J514
D UNF 7/16" L90K NP 6		
D UNF 1/ 2" L90K NP 6		
D UNF 9/16" L90K NP 6		
D UNF 9/16" L90K NP 10		
D UNF 3/ 4" L90K NP 10		
D UNF 3/ 4" L90K NP 13		
D UNF 7/ 8" L90K NP 13		
D UN1.1/16" L90K NP 19		
D UN1.5/16" L90K NP 25		

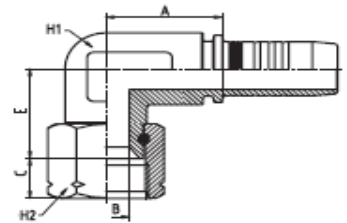

D UN/UNF okr ***	DKJ rotofit	okretni priključak s ugrađenim ležajem
D UNF 9/16" okr - NP 10		
D UNF 3/ 4" okr - NP 13		
D UNF 7/ 8" okr - NP 16		
D UN1.1/16" okr - NP 19		
D UN1.5/16" okr - NP 25		

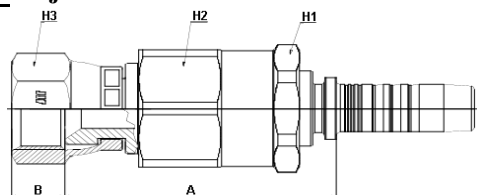

DKOM M	KOMATSU (JIS)	unutarnji konus 60°
DKOM M14x1,5 - NP 6		
DKOM M14x1,5 - NP 10		
DKOM M16x1,5 - NP 8		
DKOM M18x1,5 - NP 10		
DKOM M22x1,5 - NP 13		
DKOM M24x1,5 - NP 16		
DKOM M30x1,5 - NP 19		
DKOM M33x1,5 - NP 25		
DKOM M36x1,5 - NP 32		
DKOM M42x1,5 - NP 38		

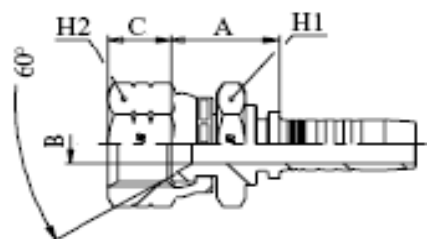

DTOY R	TOYOTA (JIS)	unutarnji konus 60°
DTOY R 1/4" - NP 6		
DTOY R 3/8" - NP 10		
DTOY R 1/2" - NP 13		
DTOY R 3/4" - NP 19		
DTOY R1" - NP 25		

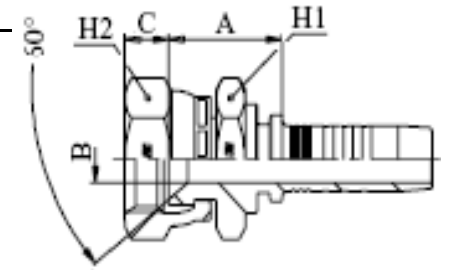

F1	BEL	DIN 2353
F1 6 - NP 5	BEL 6 - L	
F1 6 - NP 6	BEL 6 - L	
F1 8 - NP 6	BEL 8 - L	
F1 10 - NP 8	BEL 10 - L	
F1 12 - NP 10	BEL 12 - L	
F1 15 - NP 10	BEL 15 - L	
F1 15 - NP 13	BEL 15 - L	
F1 18 - NP 16	BEL 18 - L	
F1 22 - NP 16	BEL 22 - L	
F1 22 - NP 19	BEL 22 - L	
F1 28 - NP 25	BEL 28 - L	

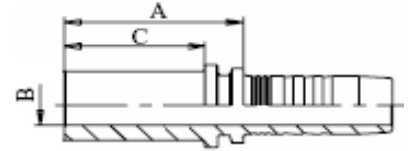

F1 L90	BEL - 90	DIN 2353
F1 6 L90 NP 6	BEL - 90 6 - L	
F1 10 L90 NP 8	BEL - 90 10 - L	
F1 12 L90 NP 10	BEL - 90 12 - L	
F1 15 L90 NP 13	BEL - 90 15 - L	
F1 18 L90 NP 16	BEL - 90 18 - L	
F1 22 L90 NP 19	BEL - 90 22 - L	
F1 28 L90 NP 25	BEL - 90 28 - L	

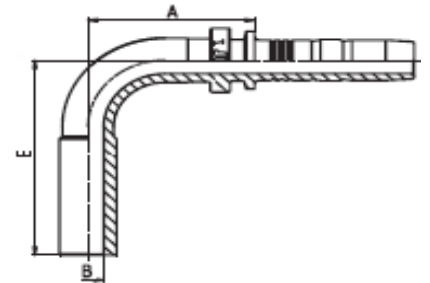

F2	BES	DIN 2353
F2 8 - NP 6	BES 6 - S	
F2 10 - NP 6	BES 10 - S	
F2 12 - NP 8	BES 12 - S	
F2 14 - NP 10	BES 14 - S	
F2 16 - NP 13	BES 16 - S	
F2 20 - NP 16	BES 20 - S	
F2 20 - NP 19	BES 20 - S	
F2 25 - NP 19	BES 25 - S	
F2 25 - NP 25	BES 25 - S	

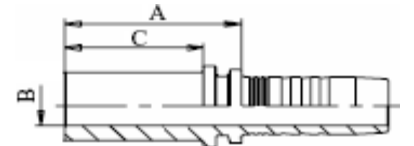

F2 L90	BES - 90	DIN 2353
F2 8 L90 NP 6	BES - 90 8 - S	
F2 12 L90 NP 8	BES - 90 12 - S	
F2 14 L90 NP 10	BES - 90 14 - S	
F2 16 L90 NP 13	BES - 90 16 - S	
F2 20 L90 NP 16	BES - 90 20 - S	
F2 25 L90 NP 19	BES - 90 25 - S	

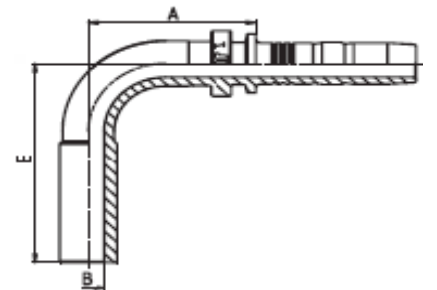

G M	AGM - F	-
G M10x1 - NP 5		
G M10x1 - NP 6		
G M22x1,5 - NP 10		
G M22x1,5 - NP 13		



G R	AGR - F	-
G R 3/8" - NP 10		
G R 1/2" - NP 10		
G R 1/2" - NP 13		
G R 3/4" - NP 19		



G R-K	AGR - K	konusni navoj
G R 1/8"K - NP 5		
G R 1/8"K - NP 6		
G R 1/4"K - NP 6		
G R 3/8"K - NP 8		
G R 3/8"K - NP 10		
G R 1/2"K - NP 10		
G R 1/2"K - NP 13		
G R 3/4"K - NP 16		
G R 3/4"K - NP 19		
G R 1"K - NP 25		

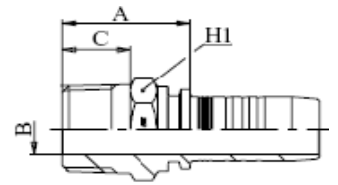

G UN/UNF/UNS	AG-ORFS	SAE J1453
G UNF 9/16" - NP 6		
G UN 11/16" - NP 8		
G UN 11/16" - NP 10		
G UN 13/16" - NP 10		
G UN 13/16" - NP 13		
G UNS1" - NP 13		
G UNS1" - NP 16		
G UN 1. 3/16" - NP 16		
G UN 1. 3/16" - NP 19		
G UN 1. 7/16" - NP 19		
G UN 1. 7/16" - NP 25		
G UN 1.11/16" - NP 32		
G UN 2" - NP 38		

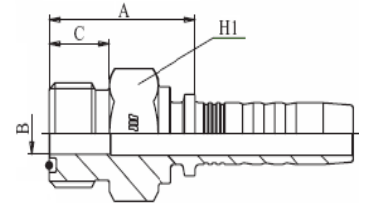

H M	AGM	-
H M12x1,5 - NP 6		
H M14x1,5 - NP 6		
H M16x1,5 - NP 8		
H M18x1,5 - NP 10		
H M22x1,5 - NP 13		
H M26x1,5 - NP 16		
H M30x1,5 - NP 19		
H M38x1,5 - NP 25		
H M45x1,5 - NP 32		

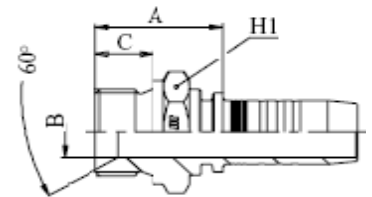

H NPT-K	AGN	SAE J516
H NPT 1/8"K - NP 3		
H NPT 1/8"K - NP 5		
H NPT 1/4"K - NP 6		
H NPT 3/8"K - NP 8		
H NPT 3/8"K - NP 10		
H NPT 1/2"K - NP 13		
H NPT 3/4"K - NP 16		
H NPT 3/4"K - NP 19		
H NPT 1"K - NP 19		
H NPT 1"K - NP 25		
H NPT 1.1/4"K - NP 25		

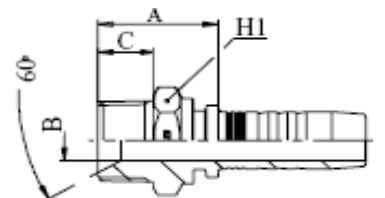

H R	AGR	-
H R 1/8" - NP 3		
H R 1/8" - NP 5		
H R 1/8" - NP 6		
H R 1/4" - NP 6		
H R 1/4" - NP 8		
H R 3/8" - NP 6		
H R 3/8" - NP 8		
H R 3/8" - NP 10		
H R 1/2" - NP 8		
H R 1/2" - NP 10		

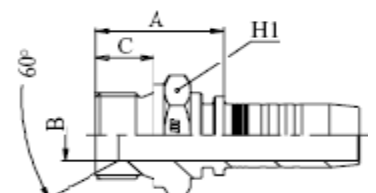

H R 1/2" - NP 13
 H R 5/8" - NP 13
 H R 5/8" - NP 16
 H R 3/4" - NP 13
 H R 3/4" - NP 16
 H R 3/4" - NP 19
 H R1" - NP 19
 H R1" - NP 25
 H R1.1/4" - NP 25
 H R1.1/4" - NP 32
 H R1.1/2" - NP 32
 H R1.1/2" - NP 38
 H R2" - NP 38
 H R2" - NP 50

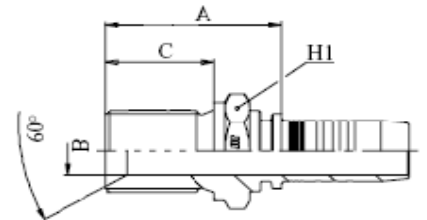
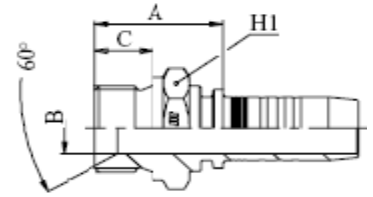

H R p	-	produženi navoj
H R 1/2" p - NP 13		
H R 5/8" p - NP 16		
H R 3/4" p - NP 19		

H R okr ***	AGR rotofit	okretni priključak s ugrađenim ležajem
HR 3/8" okr - NP 10		
HR 1/2" okr - NP 13		
HR 5/8" okr - NP 16		
HR 3/4" okr - NP 19		
HR1" okr - NP 25		

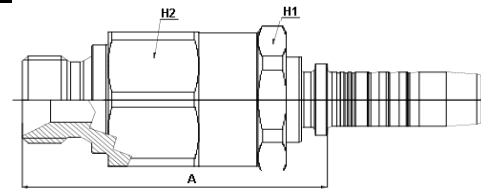

J1 M	CEL	DIN 3853
J1 M12x1,5 - NP 5	CEL 6 - L	
J1 M12x1,5 - NP 6	CEL 6 - L	
J1 M14x1,5 - NP 6	CEL 8 - L	
J1 M16x1,5 - NP 6	CEL 10 - L	
J1 M16x1,5 - NP 8	CEL 10 - L	
J1 M16x1,5 - NP 10	CEL 10 - L	
J1 M18x1,5 - NP 8	CEL 12 - L	
J1 M18x1,5 - NP 10	CEL 12 - L	
J1 M22x1,5 - NP 10	CEL 15 - L	
J1 M22x1,5 - NP 13	CEL 15 - L	
J1 M26x1,5 - NP 13	CEL 18 - L	
J1 M26x1,5 - NP 16	CEL 18 - L	
J1 M30x2 - NP 19	CEL 22 - L	
J1 M36x2 - NP 25	CEL 28 - L	
J1 M45x2 - NP 32	CEL 35 - L	
J1 M52x2 - NP 38	CEL 42 - L	

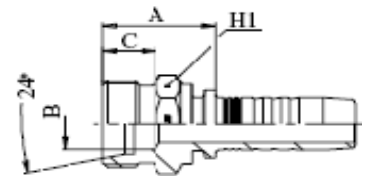

J2 M	CES	DIN 3853
J2 M14x1,5 - NP 6	CES 6 - S	
J2 M16x1,5 - NP 6	CES 8 - S	
J2 M18x1,5 - NP 6	CES 10 - S	
J2 M18x1,5 - NP 8	CES 10 - S	
J2 M20x1,5 - NP 8	CES 12 - S	
J2 M20x1,5 - NP 10	CES 12 - S	
J2 M22x1,5 - NP 10	CES 14 - S	
J2 M24x1,5 - NP 13	CES 16 - S	
J2 M30x2 - NP 16	CES 20 - S	
J2 M30x2 - NP 19	CES 20 - S	
J2 M36x2 - NP 19	CES 25 - S	
J2 M36x2 - NP 25	CES 25 - S	
J2 M42x2 - NP 25	CES 30 - S	
J2 M52x2 - NP 32	CES 38 - S	

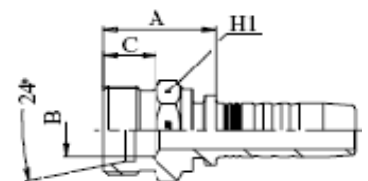

K M	-	-
K M14x1,5 - NP 6		
K M16x1,5 - NP 8		
K M18x1,5 - NP 10		
K M22x1,5 - NP 13		
K M27x2 - NP 16		
K M33x2 - NP 19		
K M39x2 - NP 25		

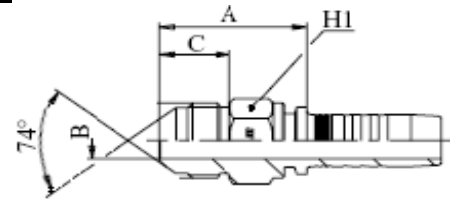

K UN/UNF	AGJ (JIC)	SAE J514
K UNF 7/16" - NP 6		
K UNF 1/ 2" - NP 6		
K UNF 1/ 2" - NP 8		
K UNF 9/16" - NP 6		
K UNF 9/16" - NP 8		
K UNF 9/16" - NP 10		
K UNF 5/ 8" - NP 10		
K UNF 3/ 4" - NP 10		
K UNF 3/ 4" - NP 13		
K UNF 7/ 8" - NP 10		
K UNF 7/ 8" - NP 13		
K UNF 7/ 8" - NP 16		
K UN1.1/16" - NP 13		
K UN1.1/16" - NP 16		
K UN1.1/16" - NP 19		
K UN1.1/16" - NP 25		
K UN1.3/16" - NP 19		
K UN1.5/16" - NP 19		
K UN1.5/16" - NP 25		
K UN1.5/ 8" - NP 25		
K UN1.5/ 8" - NP 32		
K UN1.7/ 8" - NP 38		

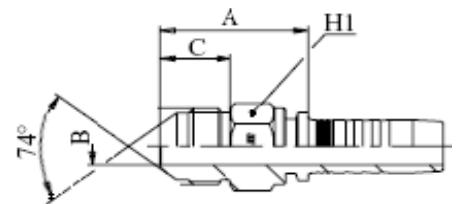

M1 M	DKOL	DIN 3865
M1 M12x1,5 - NP 3	DKOL 6 - L	
M1 M12x1,5 - NP 5	DKOL 6 - L	
M1 M12x1,5 - NP 6	DKOL 6 - L	
M1 M14x1,5 - NP 5	DKOL 8 - L	
M1 M14x1,5 - NP 6	DKOL 8 - L	
M1 M14x1,5 - NP 8	DKOL 8 - L	
M1 M16x1,5 - NP 6	DKOL 10 - L	
M1 M16x1,5 - NP 8	DKOL 10 - L	
M1 M16x1,5 - NP 10	DKOL 10 - L	
M1 M18x1,5 - NP 6	DKOL 12 - L	
M1 M18x1,5 - NP 8	DKOL 12 - L	
M1 M18x1,5 - NP 10	DKOL 12 - L	
M1 M18x1,5 - NP 13	DKOL 12 - L	
M1 M22x1,5 - NP 10	DKOL 15 - L	
M1 M22x1,5 - NP 13	DKOL 15 - L	
M1 M26x1,5 - NP 13	DKOL 18 - L	
M1 M26x1,5 - NP 16	DKOL 18 - L	
M1 M30x2 - NP 16	DKOL 22 - L	
M1 M30x2 - NP 19	DKOL 22 - L	
M1 M36x2 - NP 19	DKOL 28 - L	
M1 M36x2 - NP 25	DKOL 28 - L	
M1 M45x2 - NP 32	DKOL 35 - L	
M1 M52x2 - NP 38	DKOL 42 - L	

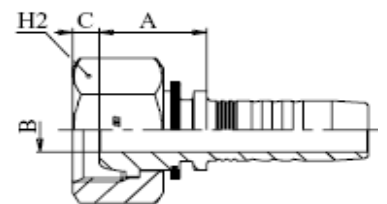

M1 M L45	DKOL - 45	DIN 3865
M1 M14x1,5 L45 NP 6	DKOL - 45 8 - L	
M1 M16x1,5 L45 NP 6	DKOL - 45 10 - L	
M1 M16x1,5 L45 NP 8	DKOL - 45 10 - L	
M1 M18x1,5 L45 NP 8	DKOL - 45 12 - L	

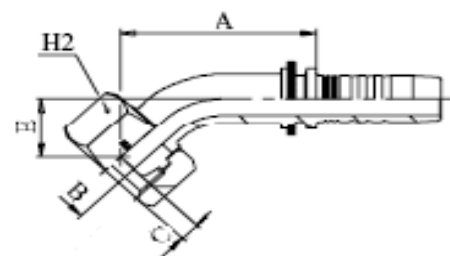

M1 M18x1,5 L45 NP 10	DKOL - 45 12 - L
M1 M22x1,5 L45 NP 13	DKOL - 45 15 - L
M1 M26x1,5 L45 NP 16	DKOL - 45 18 - L
M1 M30x2 L45 NP 19	DKOL - 45 22 - L
M1 M36x2 L45 NP 25	DKOL - 45 28 - L
M1 M45x2 L45 NP 32	DKOL - 45 35 - L
M1 M52x2 L45 NP 38	DKOL - 45 42 - L

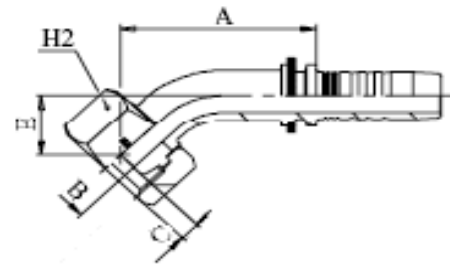

M1 M L90	DKOL - 90	DIN 3865
M1 M12x1,5 L90 NP 5	DKOL - 90 6 - L	
M1 M12x1,5 L90 NP 6	DKOL - 90 6 - L	
M1 M14x1,5 L90 NP 5	DKOL - 90 8 - L	
M1 M14x1,5 L90 NP 6	DKOL - 90 8 - L	
M1 M16x1,5 L90 NP 6	DKOL - 90 10 - L	
M1 M16x1,5 L90 NP 8	DKOL - 90 10 - L	
M1 M16x1,5 L90 NP 10	DKOL - 90 10 - L	
M1 M18x1,5 L90 NP 6	DKOL - 90 12 - L	
M1 M18x1,5 L90 NP 8	DKOL - 90 12 - L	
M1 M18x1,5 L90 NP 10	DKOL - 90 12 - L	
M1 M22x1,5 L90 NP 10	DKOL - 90 15 - L	
M1 M22x1,5 L90 NP 13	DKOL - 90 15 - L	
M1 M26x1,5 L90 NP 13	DKOL - 90 18 - L	
M1 M26x1,5 L90 NP 16	DKOL - 90 18 - L	
M1 M30x2 L90 NP 16	DKOL - 90 22 - L	
M1 M30x2 L90 NP 19	DKOL - 90 22 - L	
M1 M36x2 L90 NP 19	DKOL - 90 28 - L	
M1 M36x2 L90 NP 25	DKOL - 90 28 - L	
M1 M45x2 L90 NP 32	DKOL - 90 35 - L	
M1 M52x2 L90 NP 38	DKOL - 90 42 - L	

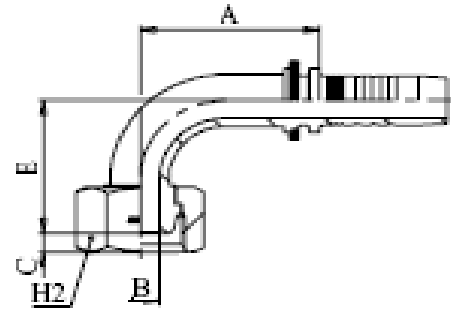

M2 M	DKOS	DIN 3865
M2 M14x1,5 - NP 6	DKOS 6 - S	
M2 M16x1,5 - NP 5	DKOS 8 - S	
M2 M16x1,5 - NP 6	DKOS 8 - S	
M2 M18x1,5 - NP 6	DKOS 10 - S	
M2 M18x1,5 - NP 8	DKOS 10 - S	
M2 M20x1,5 - NP 8	DKOS 12 - S	
M2 M20x1,5 - NP 10	DKOS 12 - S	
M2 M22x1,5 - NP 10	DKOS 14 - S	
M2 M22x1,5 - NP 13	DKOS 14 - S	
M2 M24x1,5 - NP 13	DKOS 16 - S	
M2 M30x2 - NP 16	DKOS 20 - S	
M2 M30x2 - NP 19	DKOS 20 - S	
M2 M36x2 - NP 19	DKOS 25 - S	
M2 M36x2 - NP 25	DKOS 25 - S	
M2 M42x2 - NP 25	DKOS 30 - S	
M2 M52x2 - NP 32	DKOS 38 - S	

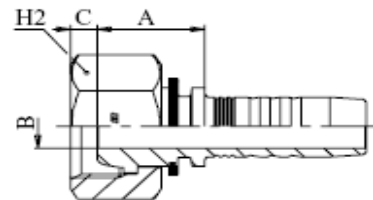

M2 M L45	DKOS - 45	DIN 3865
M2 M16x1,5 L45 NP 6	DKOS - 45 8 - S	
M2 M18x1,5 L45 NP 6	DKOS - 45 10 - S	
M2 M18x1,5 L45 NP 8	DKOS - 45 10 - S	
M2 M20x1,5 L45 NP 8	DKOS - 45 12 - S	
M2 M20x1,5 L45 NP 10	DKOS - 45 12 - S	
M2 M22x1,5 L45 NP 10	DKOS - 45 14 - S	
M2 M22x1,5 L45 NP 13	DKOS - 45 14 - S	
M2 M24x1,5 L45 NP 13	DKOS - 45 16 - S	
M2 M30x2 L45 NP 16	DKOS - 45 20 - S	
M2 M30x2 L45 NP 19	DKOS - 45 20 - S	
M2 M36x2 L45 NP 19	DKOS - 45 25 - S	
M2 M36x2 L45 NP 25	DKOS - 45 25 - S	
M2 M42x2 L45 NP 25	DKOS - 45 30 - S	
M2 M52x2 L45 NP 32	DKOS - 45 38 - S	

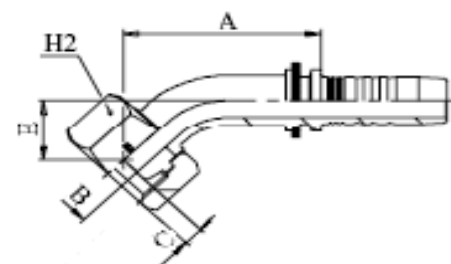

M2 M L90	DKOS - 90	DIN 3865
M2 M14x1,5 L90 NP 6	DKOS - 90 6 - S	
M2 M16x1,5 L90 NP 6	DKOS - 90 8 - S	
M2 M18x1,5 L90 NP 6	DKOS - 90 10 - S	
M2 M18x1,5 L90 NP 8	DKOS - 90 10 - S	
M2 M20x1,5 L90 NP 8	DKOS - 90 12 - S	
M2 M20x1,5 L90 NP 10	DKOS - 90 12 - S	
M2 M22x1,5 L90 NP 10	DKOS - 90 14 - S	
M2 M22x1,5 L90 NP 13	DKOS - 90 14 - S	
M2 M24x1,5 L90 NP 13	DKOS - 90 16 - S	
M2 M30x2 L90 NP 16	DKOS - 90 20 - S	
M2 M30x2 L90 NP 19	DKOS - 90 20 - S	
M2 M36x2 L90 NP 19	DKOS - 90 25 - S	
M2 M36x2 L90 NP 25	DKOS - 90 25 - S	
M2 M42x2 L90 NP 25	DKOS - 90 30 - S	
M2 M52x2 L90 NP 32	DKOS - 90 38 - S	

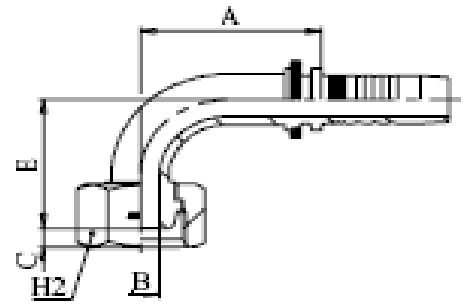

P1	SFL	SAE 3000
P1 30 - NP 13	SFL 1/2"	
P1 38 - NP 13	SFL 3/4"	
P1 38 - NP 16	SFL 3/4"	
P1 38 - NP 19	SFL 3/4"	
P1 45 - NP 16	SFL 1"	
P1 45 - NP 19	SFL 1"	
P1 45 - NP 25	SFL 1"	
P1 51 - NP 25	SFL 1.1/4"	
P1 51 - NP 32	SFL 1.1/4"	
P1 60 - NP 32	SFL 1.1/2"	
P1 60 - NP 38	SFL 1.1/2"	
P1 72 - NP 38	SFL 2"	
P1 72 - NP 50	SFL 2"	
P1 84 - NP 50	SFL 2.1/2"	

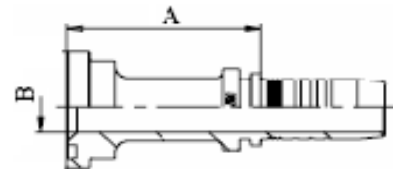

P1 L45	SFL - 45	SAE 3000
P1 30 L45 NP 13	SFL - 45 1/2"	
P1 38 L45 NP 13	SFL - 45 3/4"	
P1 38 L45 NP 16	SFL - 45 3/4"	
P1 38 L45 NP 19	SFL - 45 3/4"	
P1 45 L45 NP 16	SFL - 45 1"	
P1 45 L45 NP 19	SFL - 45 1"	
P1 45 L45 NP 25	SFL - 45 1"	
P1 51 L45 NP 25	SFL - 45 1.1/4"	
P1 51 L45 NP 32	SFL - 45 1.1/4"	
P1 60 L45 NP 32	SFL - 45 1.1/2"	
P1 60 L45 NP 38	SFL - 45 1.1/2"	
P1 72 L45 NP 38	SFL - 45 2"	
P1 72 L45 NP 50	SFL - 45 2"	

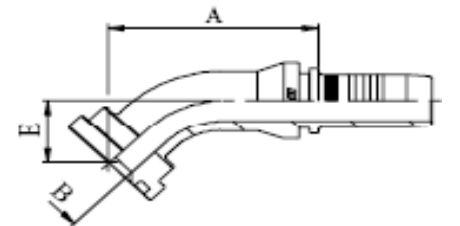

P1 L90	SFL - 90	SAE 3000
P1 30 L90 NP 13	SFL - 90 1/2"	
P1 38 L90 NP 13	SFL - 90 3/4"	
P1 38 L90 NP 16	SFL - 90 3/4"	
P1 38 L90 NP 19	SFL - 90 3/4"	
P1 45 L90 NP 16	SFL - 90 1"	
P1 45 L90 NP 19	SFL - 90 1"	
P1 45 L90 NP 25	SFL - 90 1"	
P1 51 L90 NP 25	SFL - 90 1.1/4"	
P1 51 L90 NP 32	SFL - 90 1.1/4"	
P1 60 L90 NP 32	SFL - 90 1.1/2"	
P1 60 L90 NP 38	SFL - 90 1.1/2"	
P1 72 L90 NP 38	SFL - 90 2"	
P1 72 L90 NP 50	SFL - 90 2"	

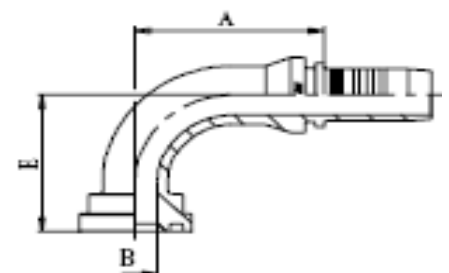

Stega dvodjelna za P1		FL	SAE 3000
P1 30	stega dvodjelna	FL 1/2"	
P1 38	stega dvodjelna	FL 3/4"	
P1 45	stega dvodjelna	FL 1"	
P1 51	stega dvodjelna	FL 1.1/4"	
P1 60	stega dvodjelna	FL 1.1/2"	
P1 72	stega dvodjelna	FL 2"	
P1 84	stega dvodjelna	FL 2.1/2"	

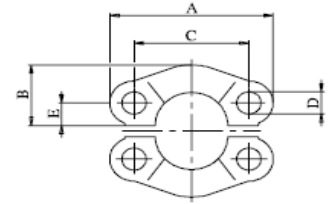

P2		SFS	SAE 6000
P2 32	- NP 13	SFS 1/2"	
P2 32	- NP 16	SFS 1/2"	
P2 41	- NP 13	SFS 3/4"	
P2 41	- NP 16	SFS 3/4"	
P2 41	- NP 19	SFS 3/4"	
P2 41	- NP 25	SFS 3/4"	
P2 48	- NP 19	SFS 1"	
P2 48	- NP 25	SFS 1"	
P2 48	- NP 32	SFS 1"	
P2 54	- NP 25	SFS 1.1/4"	
P2 54	- NP 32	SFS 1.1/4"	
P2 64	- NP 32	SFS 1.1/2"	
P2 64	- NP 38	SFS 1.1/2"	
P2 80	- NP 50	SFS 2"	

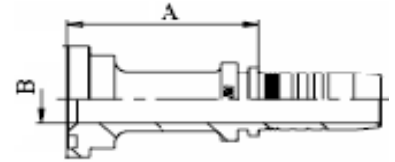

P2 L45		SFS - 45	SAE 6000
P2 32	L45 NP 13	SFS - 45 1/2"	
P2 32	L45 NP 16	SFS - 45 1/2"	
P2 41	L45 NP 13	SFS - 45 3/4"	
P2 41	L45 NP 16	SFS - 45 3/4"	
P2 41	L45 NP 19	SFS - 45 3/4"	
P2 48	L45 NP 19	SFS - 45 1"	
P2 48	L45 NP 25	SFS - 45 1"	
P2 54	L45 NP 25	SFS - 45 1.1/4"	
P2 54	L45 NP 32	SFS - 45 1.1/4"	
P2 64	L45 NP 32	SFS - 45 1.1/2"	
P2 64	L45 NP 38	SFS - 45 1.1/2"	
P2 80	L45 NP 50	SFS - 45 2"	

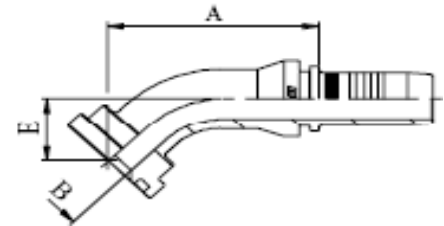

P2 L90		SFS - 90	SAE 6000
P2 32	L90 NP 13	SFS - 90 1/2"	
P2 32	L90 NP 16	SFS - 90 1/2"	
P2 41	L90 NP 13	SFS - 90 3/4"	
P2 41	L90 NP 16	SFS - 90 3/4"	
P2 41	L90 NP 19	SFS - 90 3/4"	
P2 41	L90 NP 25	SFS - 90 3/4"	
P2 48	L90 NP 19	SFS - 90 1"	
P2 48	L90 NP 25	SFS - 90 1"	
P2 48	L90 NP 32	SFS - 90 1"	
P2 54	L90 NP 25	SFS - 90 1.1/4"	
P2 54	L90 NP 32	SFS - 90 1.1/4"	
P2 64	L90 NP 32	SFS - 90 1.1/2"	
P2 64	L90 NP 38	SFS - 90 1.1/2"	
P2 80	L90 NP 50	SFS - 90 2"	

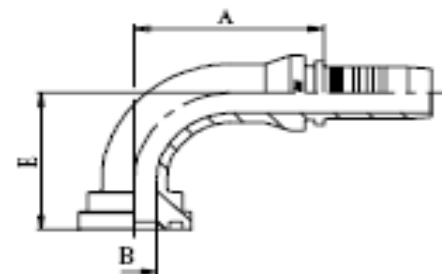

Stega dvodjelna za P2		FS	SAE 6000
P2 32	stega dvodjelna	FS 1/2"	
P2 41	stega dvodjelna	FS 3/4"	
P2 48	stega dvodjelna	FS 1"	
P2 54	stega dvodjelna	FS 1.1/4"	
P2 64	stega dvodjelna	FS 1.1/2"	
P2 80	stega dvodjelna	FS 2"	

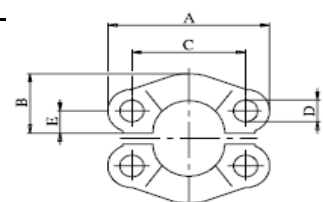

PCAT	CATERPILAR	-
PCAT 41 - NP 19	3/4"	
PCAT 48 - NP 19	1"	
PCAT 48 - NP 25	1"	
PCAT 54 - NP 25	1.1/4"	
PCAT 54 - NP 32	1.1/4"	
PCAT 64 - NP 32	1.1/2"	
PCAT 64 - NP 38	1.1/2"	

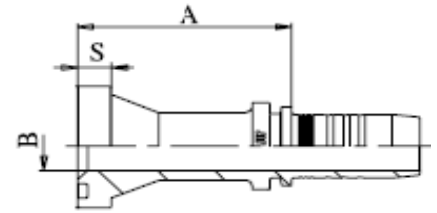

PCAT L45	CATERPILAR	-
PCAT 41 L45 NP 19	3/4"	
PCAT 48 L45 NP 19	1"	
PCAT 48 L45 NP 25	1"	
PCAT 54 L45 NP 25	1.1/4"	
PCAT 54 L45 NP 32	1.1/4"	

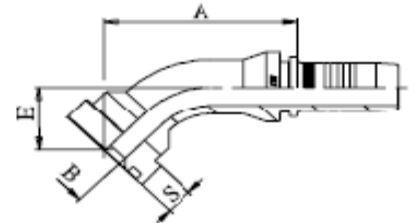

PCAT L90	CATERPILAR	-
PCAT 41 L90 NP 19	3/4"	
PCAT 48 L90 NP 19	1"	
PCAT 48 L90 NP 25	1"	
PCAT 54 L90 NP 25	1.1/4"	
PCAT 54 L90 NP 32	1.1/4"	

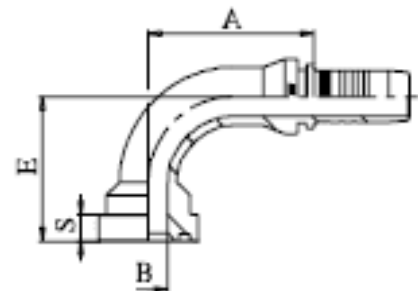

PKOM	KOMATSU	-
PKOM 34 - NP 16		

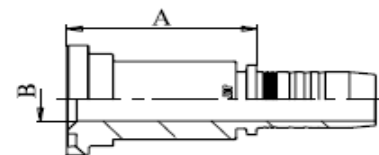

PKOM L45	KOMATSU	-
PKOM 34 L45 NP 16		

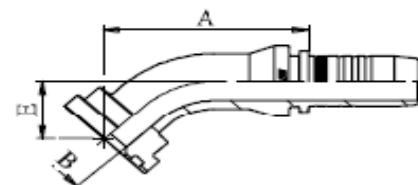

PKOM L90	KOMATSU	-
PKOM 34 L90 NP 16		

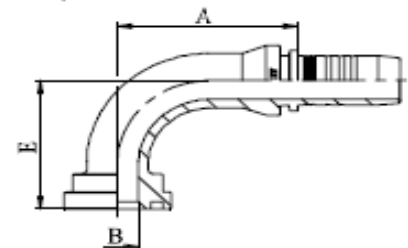

NP - NP	-	za produženje cijevi
NP 5 - NP 5		
NP 6 - NP 6		
NP 8 - NP 8		
NP 10 - NP 10		
NP 13 - NP 13		
NP 16 - NP 16		
NP 19 - NP 19		
NP 25 - NP 25		



- Napomene: ***** Okretni priključci s ugrađenim ležajem se preporučuju svugdje gdje dolazi do uvijanja cijevi. Radnog su tlaka 350 bara, omogućavaju 15 rotacija u minuti i to sa maksimalnim kutem od 40°.
- Slijedeći priključci imaju u konusu glave ugrađen O-ring koji omogućava bolje brtvljenje:
 - Svi priključci tipa M1M (oznaka DKOL), M1M L45 (DKOL - 45), M1M L90 (DKOL - 90), M2M (DKOS), M2M L45 (DKOS - 45), M2M L90 (DKOS - 90) i AR L90K (DKOR - 90-K)
 - Priključci tipa AR (oznaka DKOR), AR L45 (DKOR - 45) i AR L90 (DKOR - 90) sa navojem R1.1/4" i većim.