

PRIKLJUČCI S INTERLOCK+ NOGICAMA "MANULI" ZA VISOKOTLAČNE GUMENE CIJEVI 4SH, R13 I R15

TIP	OZNAKA / PRIMJENA	STANDARD
A R INT	MDKOR	-
A R 3/4" - NP 19 INT+		
A R 1" - NP 25 INT+		
A R 1.1/4" - NP 25 INT+		
A R 1.1/4" - NP 32 INT+		
A R 1.1/2" - NP 32 INT+		
A R 1.1/2" - NP 38 INT+		
A R 2" - NP 50 INT+		
A R L45 INT	MDKOR - 45	-
A R 3/4" L45 NP 19 INT+		
A R 1" L45 NP 25 INT+		
A R 1.1/4" L45 NP 32 INT+		
A R 1.1/2" L45 NP 38 INT+		
A R 2" L45 NP 50 INT+		
A R L90 INT	MDKOR - 90	-
A R 3/4" L90 NP 19 INT+		
A R 1" L90 NP 25 INT+		
A R 1.1/4" L90 NP 32 INT+		
A R 1.1/2" L90 NP 38 INT+		
A R 2" L90 NP 50 INT+		
C UN INT	MDK-ORFS	SAE J1453
C UN1. 3/16" - NP 19 INT+		
C UN1. 7/16" - NP 25 INT+		
C UN1.11/16" - NP 25 INT+		
C UN1.11/16" - NP 32 INT+		
C UN L45 INT	MDK-ORFS - 45	SAE J1453
C UN1. 3/16" L45 NP 19 INT+		
C UN1. 7/16" L45 NP 25 INT+		
C UN1.11/16" L45 NP 32 INT+		
C UN L90 INT	MDK-ORFS - 90	SAE J1453
C UN1. 3/16" L90 NP 19 INT+		
C UN1. 7/16" L90 NP 25 INT+		
C UN1.11/16" L90 NP 32 INT+		
D UN INT	MDKJ (JIC)	SAE J514
D UN1.1/16" - NP 19 INT+		
D UN1.5/16" - NP 25 INT+		
D UN1.5/ 8" - NP 25 INT+		
D UN1.5/ 8" - NP 32 INT+		
D UN1.7/ 8" - NP 38 INT+		

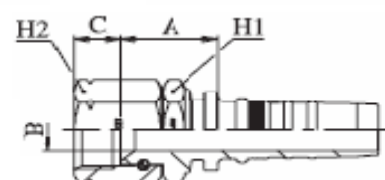

D UN L45 INT	MDKJ - 45 (JIC)	SAE J514
D UN1.1/16" L45 NP 19 INT+		
D UN1.5/16" L45 NP 25 INT+		
D UN1.5/ 8" L45 NP 32 INT+		
D UN L90 INT	MDKJ - 90 (JIC)	SAE J514
D UN1.1/16" L90 NP 19 INT+		
D UN1.5/16" L90 NP 25 INT+		
D UN1.5/ 8" L90 NP 32 INT+		
H R INT	MAGR	-
H R 3/4" - NP 19 INT+		
H R 1" - NP 25 INT+		
H R 1.1/4" - NP 25 INT+		
H R 1.1/4" - NP 32 INT+		
H R 1.1/2" - NP 38 INT+		
H R 2" - NP 50 INT+		
J2 M INT	MCES	DIN 3853 / 3861
J2 M36x2 - NP 19 INT+	MCES 25 - S	
J2 M42x2 - NP 25 INT+	MCES 30 - S	
J2 M52x2 - NP 32 INT+	MCES 38 - S	
M2 M INT	MDKOS	DIN 3865
M2 M30x2 - NP 19 INT+	MDKOS 20 - S	
M2 M36x2 - NP 19 INT+	MDKOS 25 - S	
M2 M36x2 - NP 25 INT+	MDKOS 25 - S	
M2 M42x2 - NP 19 INT+	MDKOS 30 - S	
M2 M42x2 - NP 25 INT+	MDKOS 30 - S	
M2 M52x2 - NP 32 INT+	MDKOS 38 - S	
M2 M L45 INT	MDKOS - 45	SAE 3000
M2 M36x2 L45 NP 19 INT+	MDKOS - 45 25 - S	
M2 M36x2 L45 NP 25 INT+	MDKOS - 45 25 - S	
M2 M42x2 L45 NP 25 INT+	MDKOS - 45 30 - S	
M2 M52x2 L45 NP 32 INT+	MDKOS - 45 38 - S	
M2 M L90 INT	MDKOS - 90	SAE 3000
M2 M36x2 L90 NP 19 INT+	MDKOS - 90 25 - S	
M2 M36x2 L90 NP 25 INT+	MDKOS - 90 25 - S	
M2 M42x2 L90 NP 25 INT+	MDKOS - 90 30 - S	
M2 M52x2 L90 NP 32 INT+	MDKOS - 90 38 - S	
P1 INT	MSFL	SAE 3000
P1 38 - NP 19 INT+	MSFL 3/4"	
P1 45 - NP 19 INT+	MSFL 1"	
P1 45 - NP 25 INT+	MSFL 1"	
P1 51 - NP 25 INT+	MSFL 1.1/4"	
P1 51 - NP 32 INT+	MSFL 1.1/4"	
P1 60 - NP 32 INT+	MSFL 1.1/2"	
P1 60 - NP 38 INT+	MSFL 1.1/2"	
P1 72 - NP 38 INT+	MSFL 2"	
P1 72 - NP 50 INT+	MSFL 2"	

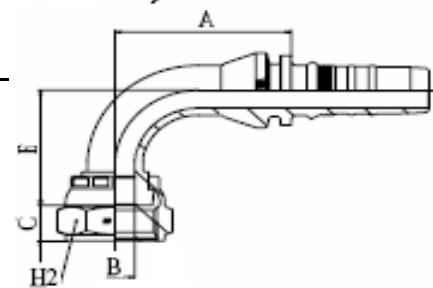
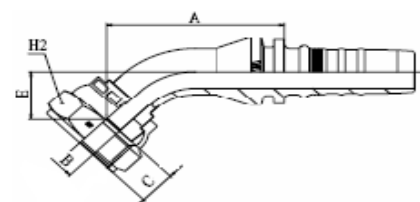
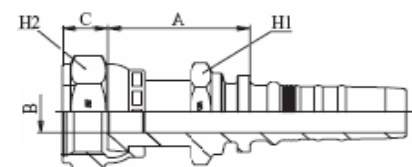
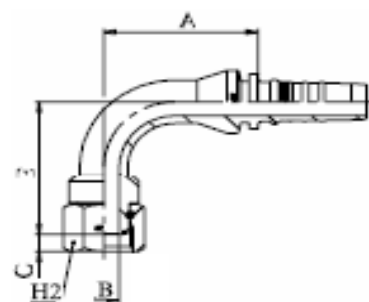
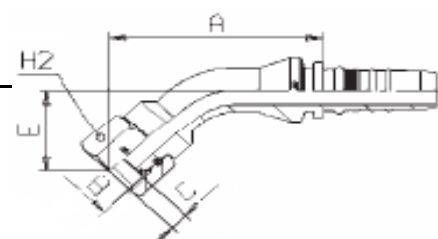
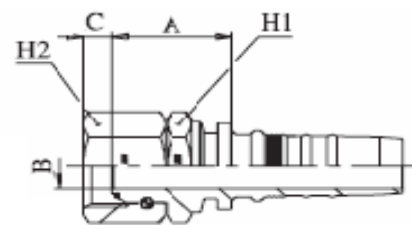
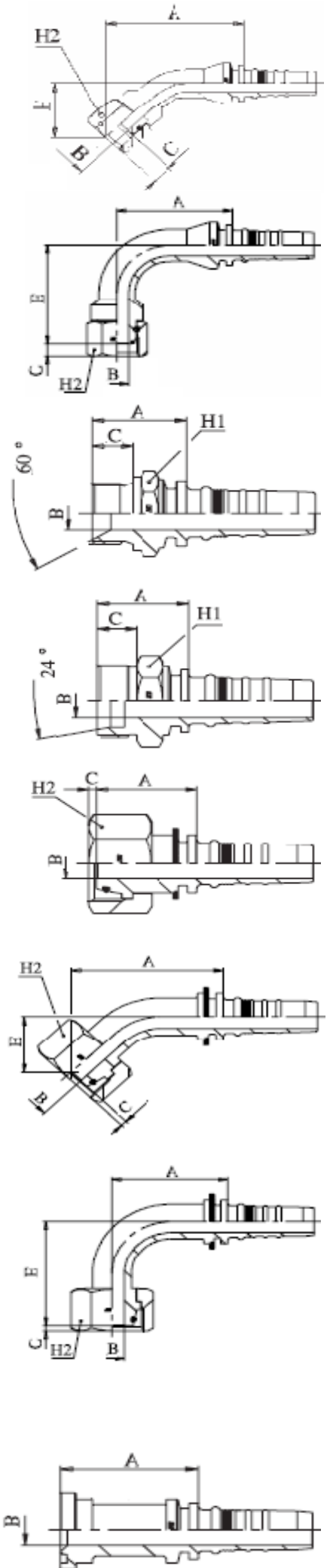

P1 L45 INT	MSFL - 45	SAE 3000
P1 38 L45 NP 19 INT+	MSFL - 45 3/4"	
P1 45 L45 NP 19 INT+	MSFL - 45 1"	
P1 45 L45 NP 25 INT+	MSFL - 45 1"	
P1 51 L45 NP 25 INT+	MSFL - 45 1.1/4"	
P1 51 L45 NP 32 INT+	MSFL - 45 1.1/4"	
P1 60 L45 NP 32 INT+	MSFL - 45 1.1/2"	
P1 60 L45 NP 38 INT+	MSFL - 45 1.1/2"	
P1 72 L45 NP 50 INT+	MSFL - 45 2"	

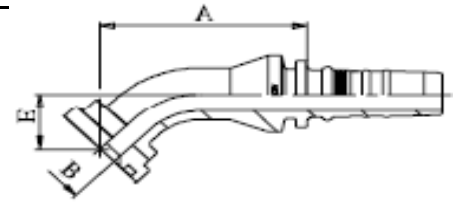

P1 L90 INT	MSFL - 90	SAE 3000
P1 38 L90 NP 19 INT+	MSFL - 90 3/4"	
P1 45 L90 NP 19 INT+	MSFL - 90 1"	
P1 45 L90 NP 25 INT+	MSFL - 90 1"	
P1 51 L90 NP 25 INT+	MSFL - 90 1.1/4"	
P1 51 L90 NP 32 INT+	MSFL - 90 1.1/4"	
P1 60 L90 NP 32 INT+	MSFL - 90 1.1/2"	
P1 60 L90 NP 38 INT+	MSFL - 90 1.1/2"	
P1 72 L90 NP 50 INT+	MSFL - 90 2"	

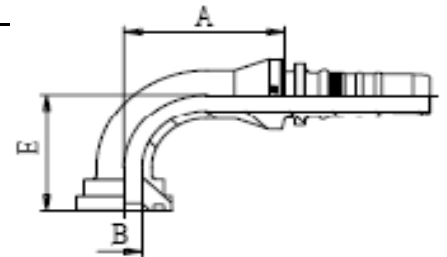

Stega dvodjelna za P1	FL	SAE 3000
P1 38 stega dvodjelna	FL 3/4"	
P1 45 stega dvodjelna	FL 1"	
P1 51 stega dvodjelna	FL 1.1/4"	
P1 60 stega dvodjelna	FL 1.1/2"	
P1 72 stega dvodjelna	FL 2"	

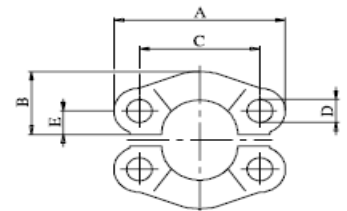

P2 INT	MSFS	SAE 6000
P2 41 - NP 19 INT+	MSFS 3/4"	
P2 41 - NP 25 INT+	MSFS 3/4"	
P2 48 - NP 19 INT+	MSFS 1"	
P2 48 - NP 25 INT+	MSFS 1"	
P2 48 - NP 32 INT+	MSFS 1"	
P2 54 - NP 25 INT+	MSFS 1.1/4"	
P2 54 - NP 32 INT+	MSFS 1.1/4"	
P2 54 - NP 38 INT+	MSFS 1.1/4"	
P2 64 - NP 32 INT+	MSFS 1.1/2"	
P2 64 - NP 38 INT+	MSFS 1.1/2"	
P2 80 - NP 38 INT+	MSFS 2"	
P2 80 - NP 50 INT+	MSFS 2"	

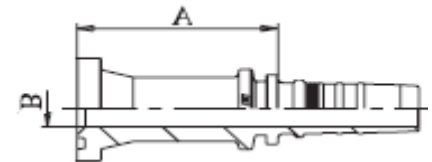

P2 L45 INT	MSFS - 45	SAE 6000
P2 41 L45 NP 19 INT+	MSFS - 45 3/4"	
P2 41 L45 NP 25 INT+	MSFS - 45 3/4"	
P2 48 L45 NP 19 INT+	MSFS - 45 1"	
P2 48 L45 NP 25 INT+	MSFS - 45 1"	
P2 48 L45 NP 32 INT+	MSFS - 45 1"	
P2 54 L45 NP 25 INT+	MSFS - 45 1.1/4"	
P2 54 L45 NP 32 INT+	MSFS - 45 1.1/4"	
P2 64 L45 NP 32 INT+	MSFS - 45 1.1/2"	
P2 64 L45 NP 38 INT+	MSFS - 45 1.1/2"	
P2 80 L45 NP 38 INT+	MSFS - 45 2"	
P2 80 L45 NP 50 INT+	MSFS - 45 2"	

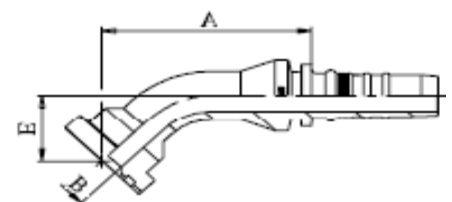

P2 L90 INT+	MSFS - 90	SAE 6000
P2 41 L90 NP 19 INT+	MSFS - 90 3/4"	
P2 41 L90 NP 25 INT+	MSFS - 90 3/4"	
P2 48 L90 NP 19 INT+	MSFS - 90 1"	
P2 48 L90 NP 25 INT+	MSFS - 90 1"	
P2 48 L90 NP 32 INT+	MSFS - 90 1"	
P2 54 L90 NP 25 INT+	MSFS - 90 1.1/4"	
P2 54 L90 NP 32 INT+	MSFS - 90 1.1/4"	
P2 54 L90 NP 38 INT+	MSFS - 90 1.1/4"	
P2 64 L90 NP 32 INT+	MSFS - 90 1.1/2"	
P2 64 L90 NP 38 INT+	MSFS - 90 1.1/2"	
P2 80 L90 NP 38 INT+	MSFS - 90 2"	
P2 80 L90 NP 50 INT+	SFS - 90 2"	

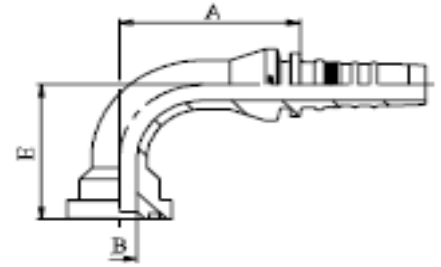

Stega dvodjelna za P2	FS	SAE 6000
P2 41 stega dvodjelna	FS 3/4"	
P2 48 stega dvodjelna	FS 1"	
P2 54 stega dvodjelna	FS 1.1/4"	
P2 64 stega dvodjelna	FS 1.1/2"	
P2 80 stega dvodjelna	FS 2"	

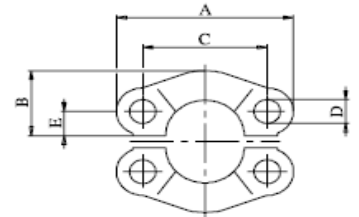

Stega jednodjelna za P2	-	-
P2 48 stega jednodjelna	1" - S	
P2 54 stega jednodjelna	1.1/4" - S	
P2 64 stega jednodjelna	1.1/2" - S	
P2 80 stega jednodjelna	2" - S	

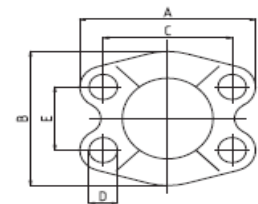

PCAT INT	CATERPILAR	-
PCAT 41 - NP 19 INT+		
PCAT 48 - NP 19 INT+		
PCAT 48 - NP 25 INT+		
PCAT 54 - NP 25 INT+		
PCAT 54 - NP 32 INT+		
PCAT 64 - NP 32 INT+		
PCAT 64 - NP 38 INT+		

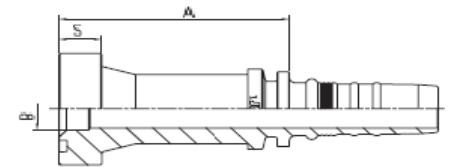

PCAT L45 INT	CATERPILAR	-
PCAT 41 L45 NP 19 INT+		
PCAT 48 L45 NP 19 INT+		
PCAT 48 L45 NP 25 INT+		
PCAT 54 L45 NP 25 INT+		
PCAT 54 L45 NP 32 INT+		
PCAT 64 L45 NP 38 INT+		

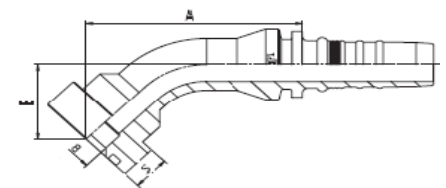

PCAT L90 INT	CATERPILAR	-
PCAT 41 L90 NP 19 INT+		
PCAT 48 L90 NP 19 INT+		
PCAT 48 L90 NP 25 INT+		
PCAT 54 L90 NP 25 INT+		
PCAT 54 L90 NP 32 INT+		
PCAT 64 L90 NP 38 INT+		

